

F4U Corsair

By Harold Andrews

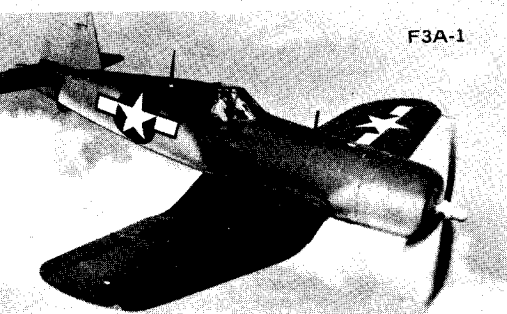

F3A-1

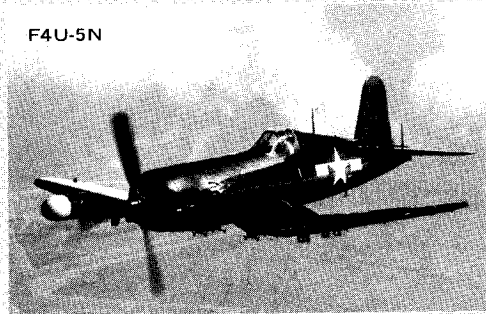

F4U-5N

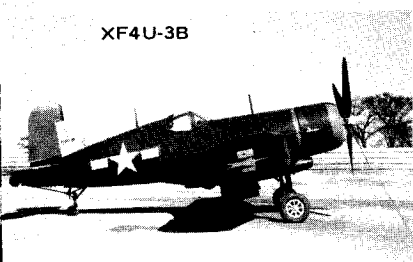

XF4U-3B

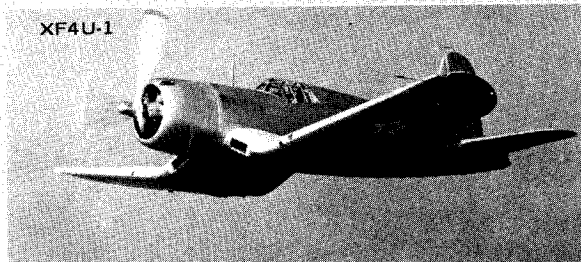

XF4U-1

It was the first single-engine fighter capable of over 400 mph.

As part of the U.S. military buildup which preceded Pearl Harbor, production of the F4U-1 was ordered. Based on European wartime experience, increased armament and gunfire protection were required, resulting in extensive redesign of the production *Corsairs*. A large self-sealing fuel tank was located over the wing in the fuselage, while three .50 machine guns were installed outboard of the prop arc in each wing. The fuselage fuel tank caused the cockpit to be moved aft, which resulted in the characteristic "long nose" of the *Corsair*. An unusual feature of the *Corsair* was the fabric covering of the outer wing panels aft of the main spar. The construction was otherwise typically all metal with fabric-covered control surfaces.

Design and construction of the initial production F4U-1s were well along when the U.S. entered WW II. To meet anticipated Navy/Marine needs, Goodyear and Brewster were also given contracts to produce *Corsairs* as the FG-1 and F3A-1, respectively, with Vought-Sikorsky retaining overall design responsibility.

June 1942 brought the first production F4U-1 flight, with testing, Navy trials and service introduction following. Early carrier trials revealed some problems with carrier landings, leading to a decision to operate *Corsairs* from land until satisfactory characteristics were achieved. Thus, the Marines became a major user, along with shore-based Navy squadrons.

While this problem was being tackled, other improvements were made in the -1 *Corsairs* and incorporated at all three production plants. The most obvious was a raised, three-panel canopy for improved visibility. At the same time, a dozen F4U-1s were being modified as F4U-2 night fighters with a radar nacelle on the right wing, outboard. Additional conversions were subsequently made and, in early 1944, these night fighters were the first *Corsairs* based on U.S. carriers. The F4U-1C, with four 20mm cannon in place of the six .50s; and the F4U and FG-1D, with additional store-carrying capability and water injection for the engine, followed. Brewster's *Corsair* production was cancelled before shifting to the -1D.

By the time the -1Ds were in service, the carrier landing problem had been solved. Changes to the main gear oleos and a taller tail wheel assembly led to full

On the occasion of the 75th Anniversary of Naval Aviation, it is notable that Vought *Corsairs* have been on board for more than two-thirds of the period.

First came the series of biplanes, starting in 1926. Before they were totally phased out, the XF4U-1 entered the scene in 1940. The inverted gull-wing *Corsairs* continued the tradition for a total of some 30 years when the last of the fighter-bomber *Corsairs* was retired. After a break, the A-7 *Corsair II* (the biplane's name was unofficial) picked up in 1965, continuing to the present, with more years to come.

So, it is appropriate to cover the first official *Corsair* on this anniversary year. Significantly, the first biplane *Corsairs* (O2Us), the F4Us and the A-7s have all played key roles in Navy and Marine Corps combat operations.

The story of the *Corsair* of WW II and

Korean operations starts in 1938. The Navy was looking for a new carrier fighter with significant increases in performance over the Grumman F4F and Brewster F2A, then in the development/test stage. In the design competition a Vought proposal — designed around the new Pratt and Whitney 1,800-hp R-2800 Double Wasp engine — was awarded an experimental prototype contract.

The most unusual feature of Vought's design was its inverted gull wing, which allowed a shorter, lighter landing gear. This provided adequate ground clearance for the large-diameter propeller required to absorb the power of what was then the largest engine available for a fighter airplane.

First flown on May 29, 1940, the XF4U-1 had an armament of four guns, two synchronized to fire through the propeller disc, the other two outboard in the wings.

carrier use of the *Corsair*. A large number of -1 and -1D *Corsairs* were provided to the British Fleet Air Arm. Their wing tips were slightly clipped to clear the lower hangar overhead on the Royal Navy carriers, where they were fully operational even before the landing gear fixes were installed. Much of Goodyear's later production was built as the -1A, for land-based use without folding wings and other carrier systems. New Zealand's RNZAF also flew -1s. As a fighter and fighter-bomber, the *Corsair* was one of the outstanding WW II combat aircraft.

Attempts to increase the *Corsair's* performance at altitude led to the experimental turbo-supercharged XF4U-3. While a few FGs were modified late in the war to FG-3 configuration, they did not become operational. The next improved engine installation was the "C" series Double Wasp, first in experimental -4s and subsequently in full production at Vought. Goodyear was in the process of changing over when production there was terminated after VJ day. The improved performance justified continued production after the war, including cannon-armed -4Bs, night fighter -4Ns, search radar-equipped -4Es, and photographic -4Ps. Goodyear's development of a much more powerful *Corsair*, the F2G with the Pratt and Whitney R-4360 engine, was also closed out in the postwar years after 10 production aircraft had been built.

The new E series R-2800 developed by Pratt and Whitney led to the -5 *Corsair*, with further performance improvements. Replacing the -4 in production in 1947, it was the first "all-metal" *Corsair*, including all-metal outer wing panels.

The FG-1Ds continued as mainstays of the Reserves, while the -5s gradually replaced the -4s in fleet squadrons. The -5N night fighters became major components of carrier air groups as the new jets took over the basic day fighter role. Some -5Ps were also built.

Production of the -5 series continued at Vought after its move to Dallas, and the Korean conflict brought the *Corsair* back once more into the forefront. F4U-4s returned in numbers to the carriers and winterized -5NL versions were built to operate better in frigid weather conditions. The Navy and Marines both very successfully employed the night fighter -5Ns and -5NLs. A low-altitude, heavily armored version of the -5 was built as the XF4U-6; production aircraft were redesignated AU-1s. Production of 110 completed the Navy acquisition of *Corsairs*, though the French F4U-7s were the last off the line. With the end of the Korean war in 1953, the *Corsairs* were rapidly released from operational squadrons, though they continued another few years in support roles.

Furnished to several other countries, particularly Central and South America, as well as France, *Corsairs* continued in operational use and in intermittent combat for many more years. They also made their debut in air races soon after WW II, especially with the R-4360 engine, and established a winning record. With their unique wing configuration and outstanding performance, the more than 12,500 built are well commemorated by the few that can still be regularly seen flying at air shows and air races, and those in many museums. ■

F4U-1C

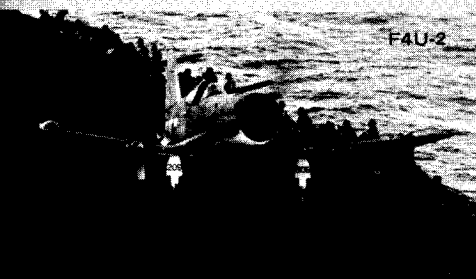
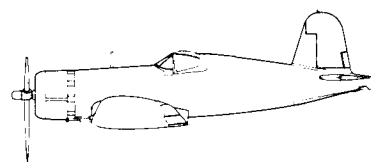
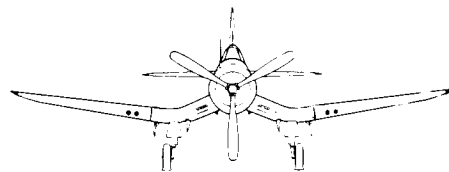
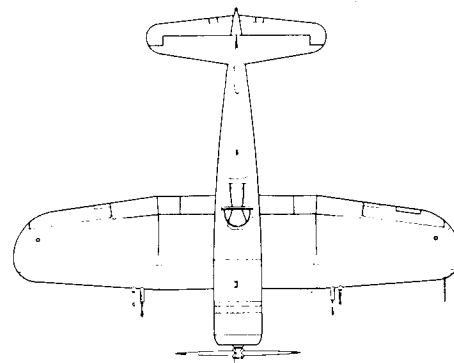
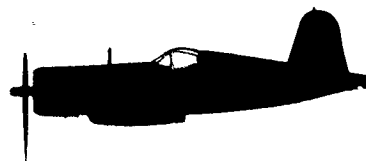

F4U-2

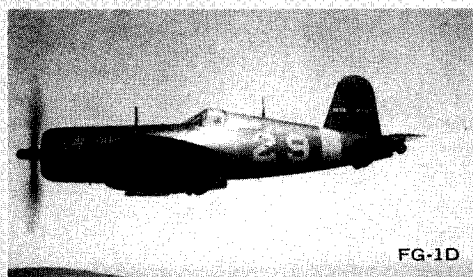

FG-1D

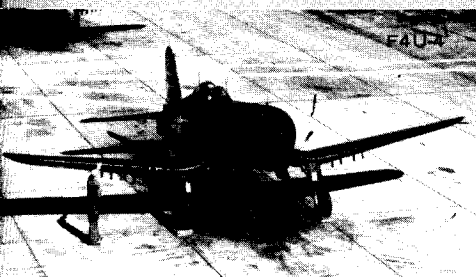

F4U-4

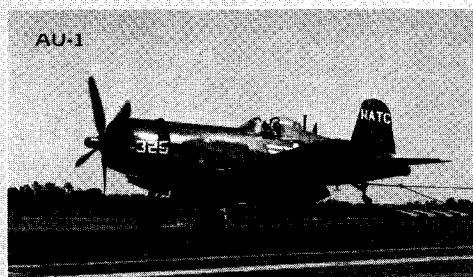

AU-1

	F4U-1	F4U-5
Length	33'4"	34'6"
Height	14'11"	14'0"
Span	41'0"	41'0"
Gross weight	12,039 lbs.	12,902 lbs.
Engine	P&W R-2800-8 2,000 hp	P&W R-2800-32W 2,300 hp
Performance		
Max. speed	407 mph	462 mph
Service ceiling	36,800'	43,500'
Range	1,515 mi.	1,036 mi.
Crew	One	One
Armament:	Six .50 machine guns and one 1,000-lb. bomb (by field mod).	Four 20mm cannon and up to two 1,600-lb. bombs plus eight 5" rockets.

DECLASSIFIED

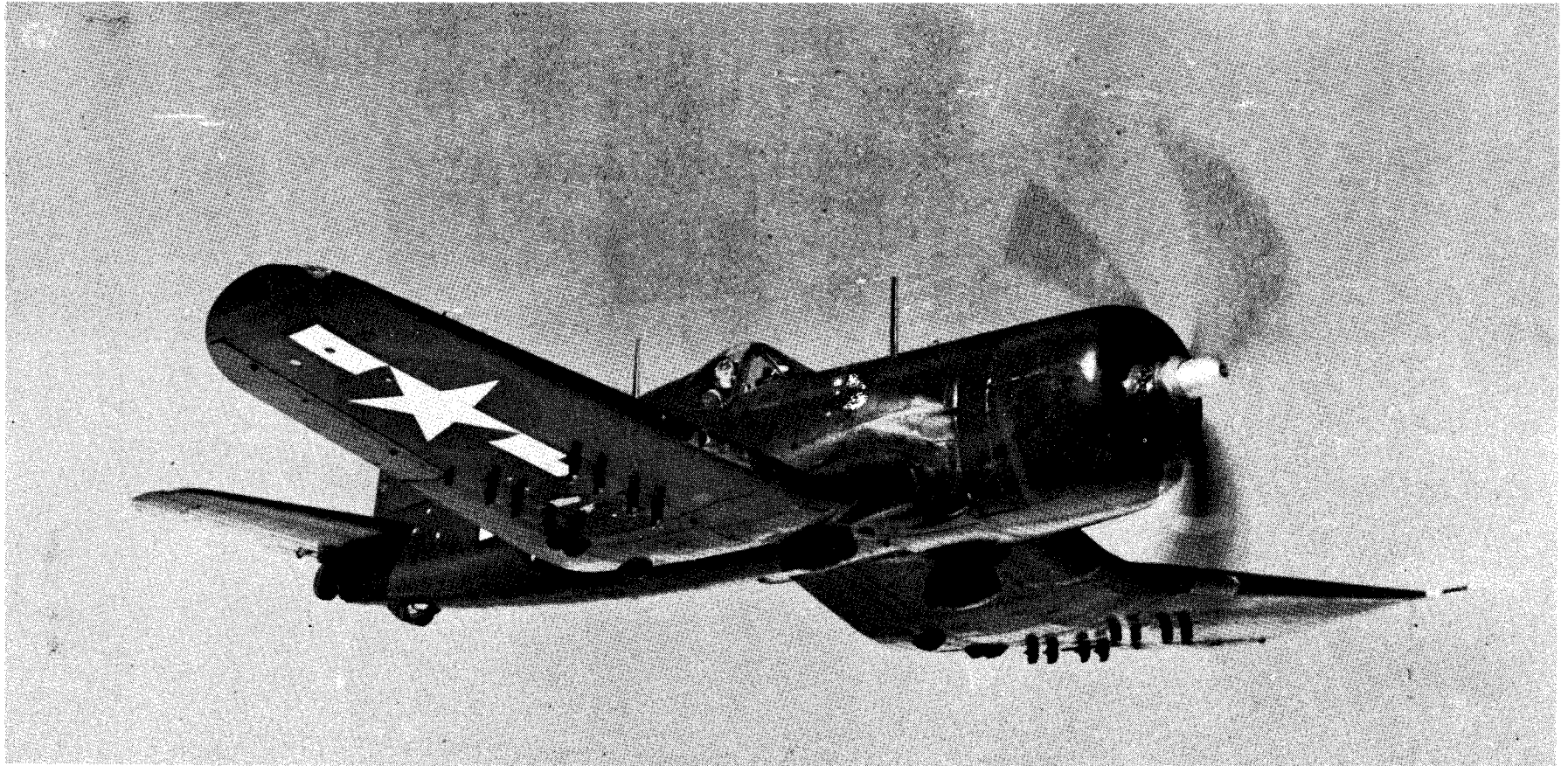

STANDARD AIRCRAFT CHARACTERISTICS
F4U-4 "CORSAIR"

BUREAU OF AERONAUTICS
NAVY DEPARTMENT

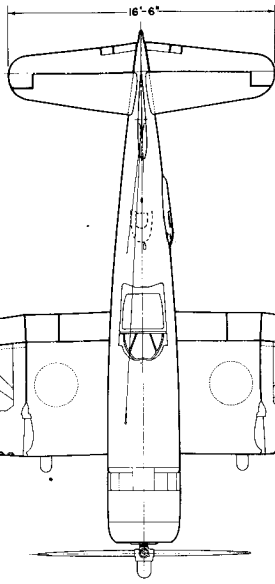

WING AREA - 314 SQ. FT.
WING SECTION -
N.A.C.A. 2301B-23009
M.A.C. - 94.0°
PROP. - HAMILTON STD. C. S.
BLADE DESIGN NO. 6501A-0
ASPECT RATIO 5.4

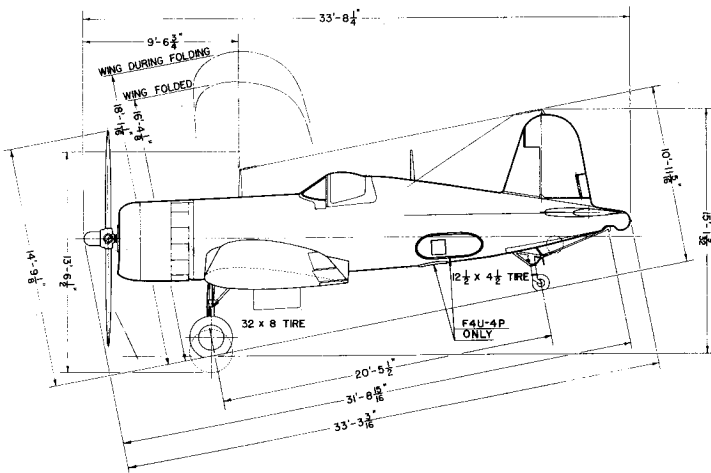
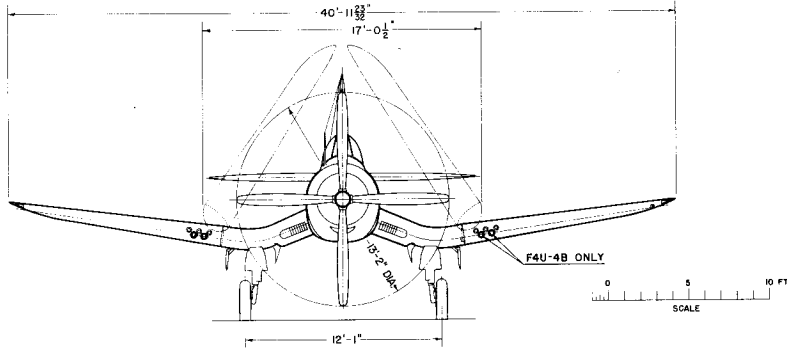

DESCRIPTIVE ARRANGEMENT

BUREAU OF AERONAUTICS
NAVY DEPARTMENT

- BULLET RESISTANT GLASS ARMOR PLATE
- DEFLECTION PLATE
- ▨ SELF-SEALING TANKS
- ⊠ NON SELF-SEALING TANKS

F4U-4, -4B, -4P
PROTECTION

- | | |
|-----------------------|-----------|
| 1. PILOT FORWARD | 36.5 LBS. |
| 2. PILOT AFT | 60.2 LBS. |
| 3. SELF-SEALING CEELS | 177 LBS. |
| 4. DEFLECTION PLATE | 20 LBS. |
| 5. ENGINE ARMOR | 175 LBS. |

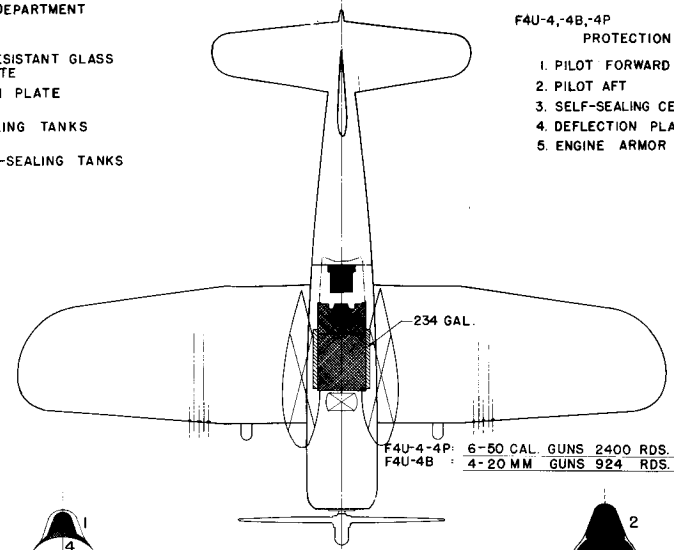

F4U-4-4P: 6-50 CAL. GUNS 2400 RDS. AMMUNITION
F4U-4B: 4-20 MM GUNS 924 RDS. AMMUNITION

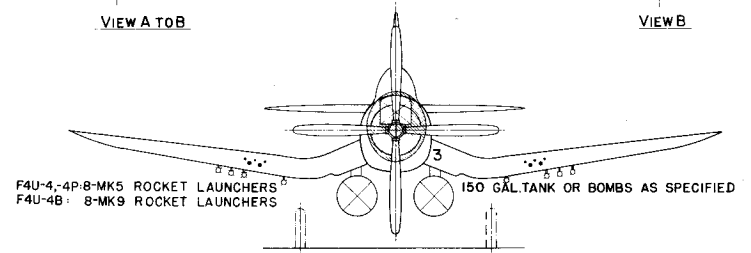
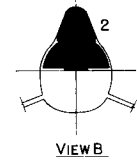
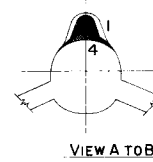

F4U-4, -4P: 8-MK5 ROCKET LAUNCHERS
F4U-4B: 8-MK9 ROCKET LAUNCHERS
150 GAL. TANK OR BOMBS AS SPECIFIED

0 5 10 FT.
SCALE

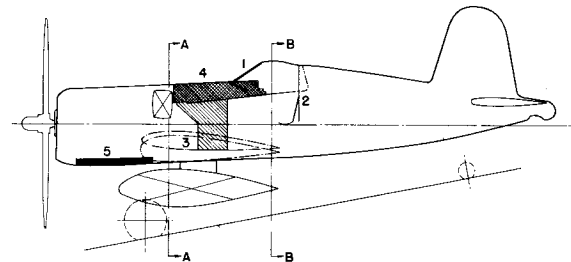

ARMAMENT & TANKS

MISSION AND DESCRIPTION

This airplane is a conventionally powered, high performance, carrier or land based, general purpose fighter.

The primary mission is the destruction of enemy aircraft, airborne or grounded. This mission may be carried out on an offensive basis in which case the action would presumably be carried out over enemy held territory or on a defensive basis when interception of an incoming enemy attack becomes a necessity. A secondary mission of this type results from its flexibility in regard to ordnance carrying capabilities. Armed with bombs and/or rockets, within prescribed limits, it may be used to great advantage for destroying enemy ground installations.

The outstanding configuration characteristic of this low-wing monoplane is the inverted gull appearance of the wing coupled with great length of fuselage ahead of the cockpit canopy.

It is of conventional structure. The wing center section is a metal box-beam, with single-spar panels fabric covered aft of the spar. Wood ailerons, metal slotted flaps. Stabilizer of either conventional or metalite construction with fabric-covered movable surfaces. Quick-change power-plant with 13.5 gal. water tank. Folding wings.

DIMENSIONS

SPAN.....41'-0"
 LENGTH.....33'-8"
 HEIGHT.....14'-9"
 WING AREA.....314 sq. ft.
 M.A.C.....94"
 TREAD.....12'-1"

WEIGHTS

Loadings	Lbs.	L.F.
EMPTY.....	9167.....	
BASIC.....	9859.....	
DESIGN.....	10138.....	8.10
COMBAT.....	12405.....	7.25
MAX.T.O.....	16160.....	5.60
MAX.LAND.....	15000.....	

All weights are actual.

FUEL AND OIL

Gals. - No. Tanks - Location
 234.....1...Fuse.(protected)
 300.....2...Wing (drop)
 FUEL GRADE.....115/145
 FUEL SPEC.....AN-F-48

OIL

CAPACITY (Gals.).....23.5
 SPEC.....AN-O-8
 GRADE.....1100-1120

ELECTRONICS

TRANSMITTER.....RT-18/ARC-1
 RECEIVER, LF.....R-23A/ARC-5
 RECEIVER, VHF.....R-4A/ARR-A
 IFF.....RT-22/APX-1

POWER PLANT

NO. & MODEL....(1) R-2800-18W
 MFR.....P. & W.
 SUPERCH.....2 Stage, 2 Speed
 PROP.GEAR RATIO.....20:9
 PROP. MFR.....Ham. Std.
 PROP.DES.NO.....6501A-0
 NO.BL./DIA.....4/13'-2"

RATINGS

	Bhp. @	Rpm. @	Alt.
T.O.	2100	2800	S.L.
MIL.	2100	2800	1000'
	1900	2800	14000'
	1800	2800	23000'
NORMAL	1700	2600	7000'
	1630	2600	18000'
	1550	2600	26000'

SEE NOTE
 SPEC NO. N-8082

ORDNANCE

No.	Size	GUNS	
		Location	Rds.
6	.50 Cal.	Wing	2400
MK. 8-6 Illuminated Sight			

Type	Size	BOMBS	
		Location	No.
Bomb	1000#	Wing	2
Bomb	500#	Wing	2
Bomb	250#	Wing	2

ROCKETS			
HVAR	5"	Wing	8
on MK.5 Rocket Launcher			
A.R.	11.5"	Wing	2



PERFORMANCE SUMMARY

LOADING CONDITION		(1) Fighter 1-150 Gal. Tank External	(3) Rocket 2-11.75" AR 8-5" HVAR	(5) Escort 2-150 Gal. Tanks External
TAKE-OFF WEIGHT	lbs	13597	16160	14658
Fuel (fixed/drop)	lbs	1404/900	1404/	1404/1800
Bombs	lbs			
	lbs			
Wing/Power Loading (A)	lbs/so.ft.lbs/ bhp	43.3/5.7	51.5/10.5	46.7/9.5
Stall Speed--Power off	kn	81.0	88.3	84.1
Stall Speed--Power off - No Fuel	kn	73.8	84.4	74.4
Stall Speed--Power on	kn	66.9	73.0	69.5
Maximum Speed/Alt (B)	kn/ft	347/31400	303/30600	326/31000
Take-off Distance, deck -- calm	ft	790	1349	974
Take-off Distance, deck 25 kn.	ft	377	708	480
Take-off Distance, Airport	ft			
Rate of climb -- sea level (B)	ft/min	2510	1880	2320
Service Ceiling (B)	ft	38400	34800	36700
Time-to-climb 10000 ft. (B)	min	4.2	5.9	4.7
Time-to-climb 20000 ft. (B)	min	8.8	13.1	10.0
Combat Range/V av 15000	ft. n.mi/kn	1005/185	360/182	1300/180
Combat Radius/V av	ft. n.mi/kn	315/178	35/178	525/178
LOADING CONDITION		(2) Combat	(4) Combat	
GROSS WEIGHT	lbs	12480	12480	
Engine power		Maximum	Normal	
Fuel	lbs	1404	1404	
Bombs/Tanks				
Max. speed at sea level	kn	325	280	
Max. speed/ACA for	kn	393/20500	372/31800	
Combat speed/Alt.	kn/ft	378/15000	320/15000	
Rate of climb SL	ft/min	4770	2910	
Ceiling for 500 fpm R/C	ft	38500	37100	
Time-tc-climb/Alt.	min/ft	4.9/20000	7.5/20000	

NOTES

- (A) BHP at Maximum Critical Altitude
- (B) Normal BHP

Performance is based on flight test of the F4U-4 airplane.

Range and radius are based on flight test fuel consumption data of the F4U-4 airplane increased by 5%.

 Combat Condition: Two capped pylons aboard. Rocket launchers not aboard. Addition of 8 MK5-1 launchers decreases V_{max} at S.L. of Condition (2) to 318 knots and V_{max}/ACA to 384 knots/20400 ft.

DECLASSIFIED

SPEED

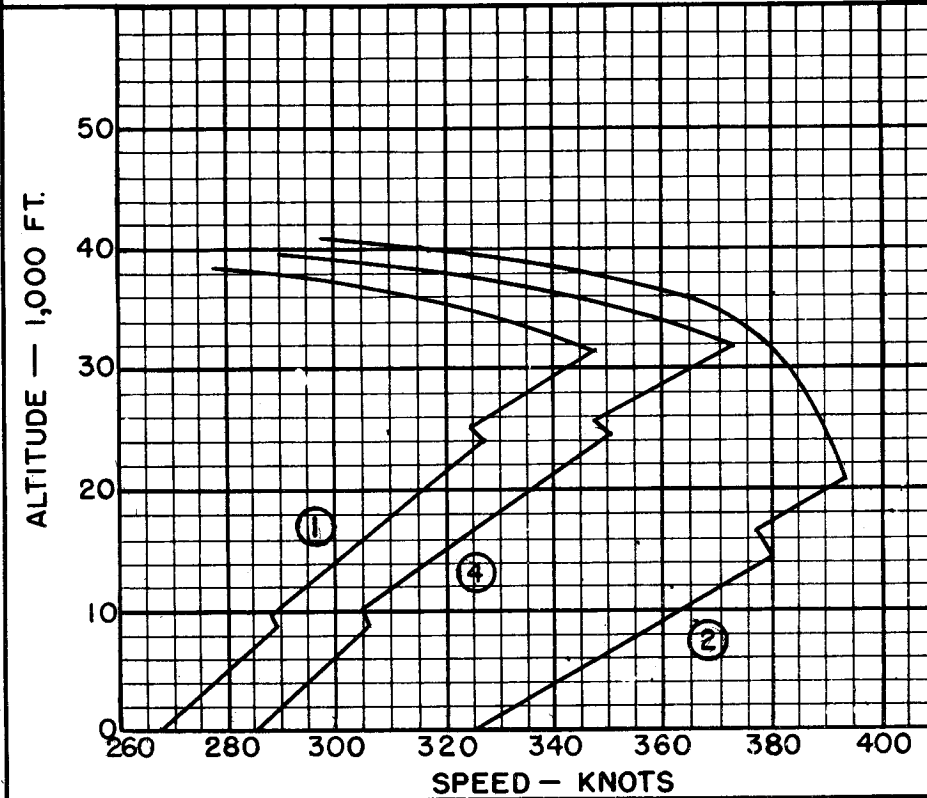

CLIMB

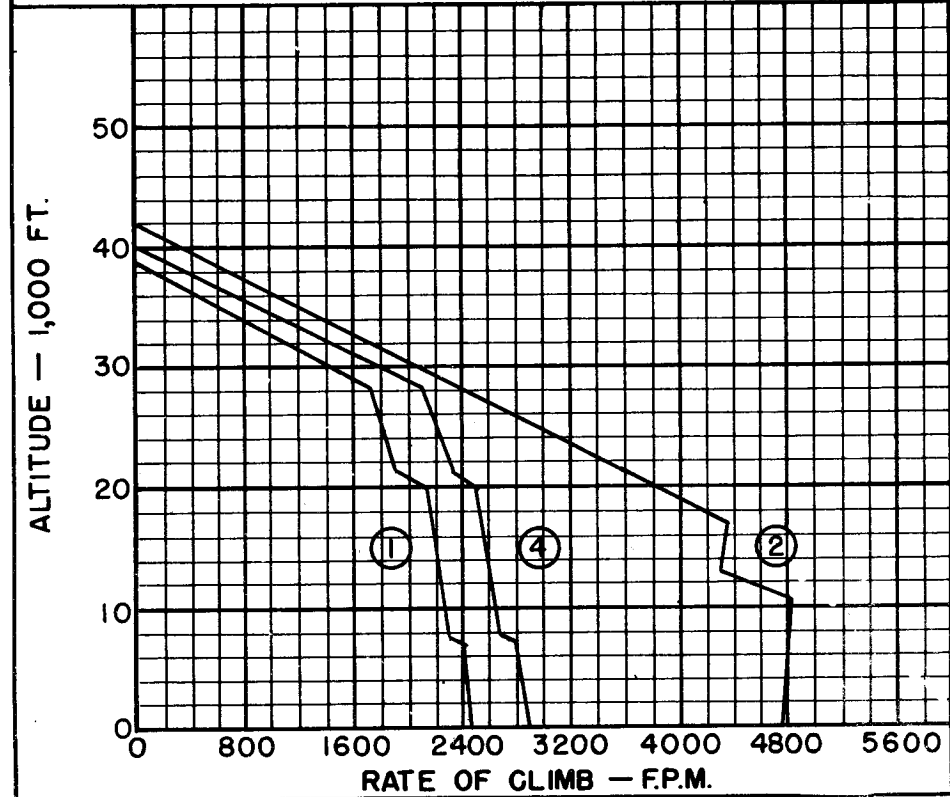

TAKE-OFF

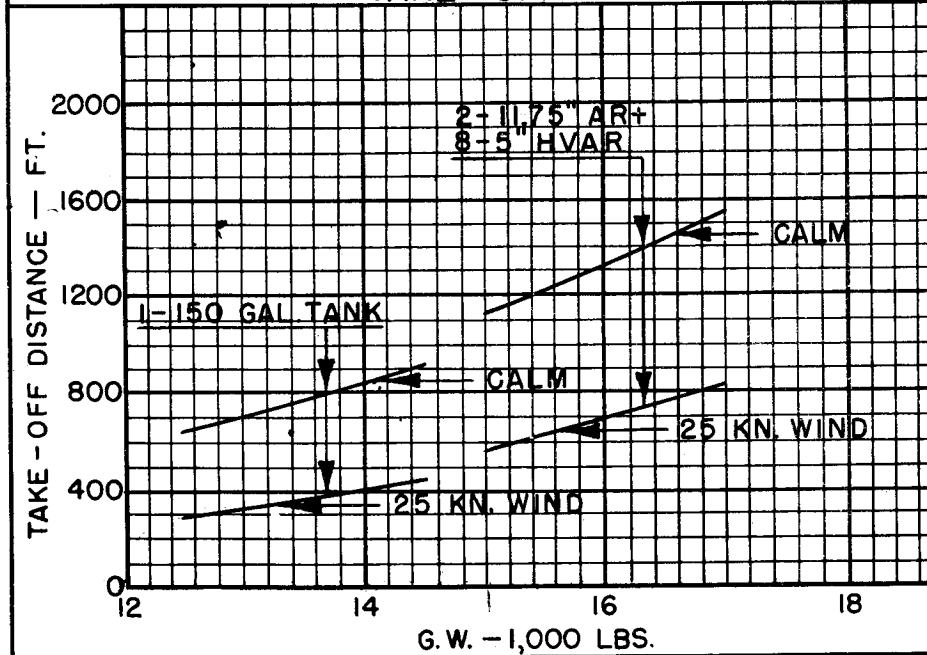

RANGE

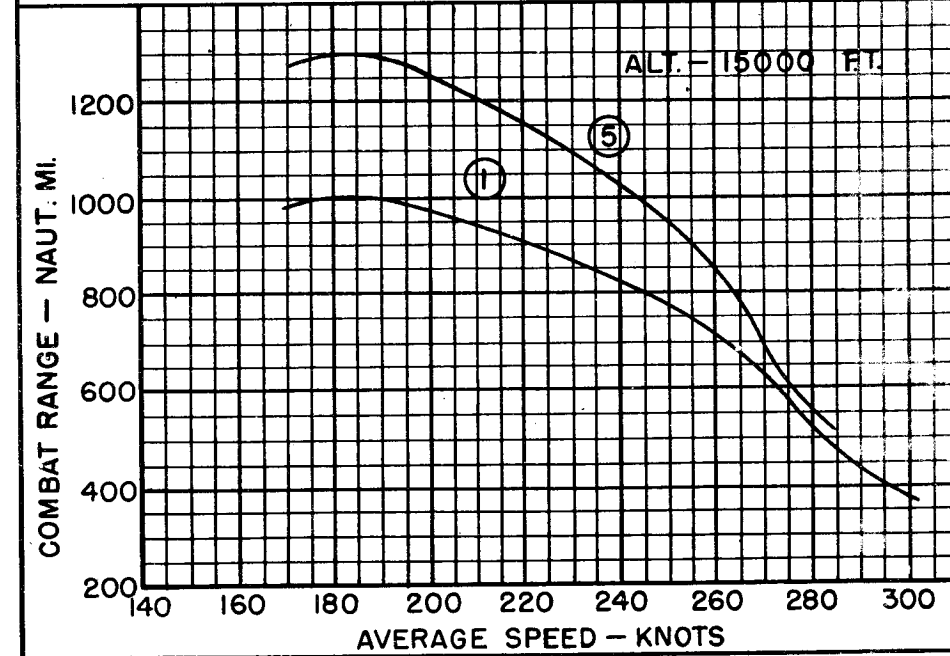

NOTES

Clean Condition: Same as Combat Condition except pylons removed. At combat power, $V_{max}/SL = 333$ knots and $V_{max}/ACA = 403$ knots/20600 ft.

Fuel transfer: Provisions are incorporated for fuel transfer from droppable to main tanks after take-off.

Spotting: 200 ft. length is required to spot 30 airplanes on the 96 ft. wide deck immediately aft of the forward ramp on the CV-9 Class carriers.

Two wing pylons (capped when not in use) aboard in all conditions. Rocket launchers carried in rocket condition only.

FIGHTER COMBAT RADIUS FORMULA NO. F-1-CONDITIONS NOS.--(1), (3), & (5)					RADIUS=CLIMB/CRUISE-OUT=CRUISE BACK		
<u>WARM-UP</u> 20 min.	<u>RENDEZVOUS</u> 20 min. at sea level	<u>CLIMB</u> to 15000 ft.	<u>CRUISE OUT</u> at 15000 ft.	<u>DROP BOMBS</u>	<u>COMBAT</u> 20 min. at 15000 ft.	<u>CRUISE BACK</u> at 1500 ft.	<u>RESERVE</u> 60 min. at
<u>TAKE-OFF</u> 1 min.	at 60% N.S.P. Auto Lean.	at N.R.P. Auto.Lean	Vel. for Max. Range Auto.Lean	FIRE ROCKETS	10 min. WEP 10 min. Mil.Pr. and descend	170 kts.TAS Auto.Lean.	Vel. for Max.Range Auto.Lean.

Engine ratings from Flight Test:

	<u>Bhp.</u>	<u>Rpm.</u>	<u>Alt.</u>
T.O.	2100	2800	S. L.
Mil.	2100	2800	3000'
	1900	2800	19000'
	1800	2800	25500'
Norm.	1700	2600	6800'
	1630	2600	20000'
	1550	2600	28000'

DECLASSIFIED

DECLASSIFIED